

OWNER'S MANUAL

**SLIMLINE
MULTIFUNCTION
BUILT-IN OVENS**

**EYE LEVEL
600 MSE
DBO 455**

**UNDER-COUNTER
600 MSU
DBO 456**

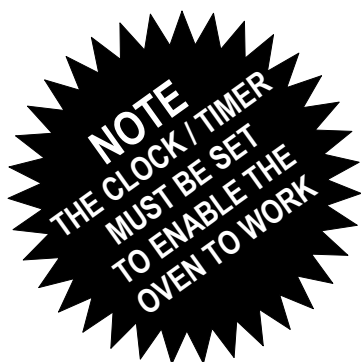

www.defy.co.za

Part Number 067 230



You can rely on Defy. To simplify



Page 2	Introduction
2	Unpacking
2	Cupboard design
2	Electrical installation
3	Under-counter installation
4	Eye level installation
4	The control panel
5	Automatic oven timer / clock
7	Multifunction oven
8	Multifunction oven - operation
8	Fan only - defrosting
8	Static oven - traditional baking
9	Fan assisted oven
9	Thermofan oven
10	Turbo grilling
11	Conventional grilling
11	Control panel cooling fan
11	Safety advice
12	Solid plate care guide
13	Solid plates
14	Ceran smooth top
15	Maintenance
16	Cleaning
17	Care guide for Stainless steel
19	Do's and Don'ts
20	Owner's responsibility
20	Problem check
21	Defy Service Centres
22	Warranty
23	Notes
24	Features

You and your Defy oven

You're going to make a great team together.

But first, it will pay if you really get to know each other.

This manual will provide you with information on how to operate and care for your oven in order that you gain the maximum benefit from it.

There is even a Do and Don't guide.

So have a cup of tea or coffee, sit down and read all about it.

Unpacking.

- Please ensure that packaging material is disposed of in a responsible manner.
- Plastic bags should be cut up to prevent children playing with them and accidentally suffocating.
- Remove all packing from the oven cavity and position the accessories.
- If the appliance is damaged in any way, do not use it. Report the damage to your dealer, who will take the necessary corrective action.

Cupboard design.

- Your Defy oven is designed to give you years of trouble free service, however it is important that it be correctly installed.
- Cooking appliances generate considerable heat. The layout and materials of the mounting cabinet should take account of the characteristics of the oven.
- Surfaces immediately adjacent to the oven should be able to withstand temperatures of up to 100°C without delaminating or discolouring.
- Overhanging doors above the oven may be subjected to heat as well as condensation if very moist foods are being cooked.

Electrical installation.

This appliance must be earthed and the manufacturer and the seller do not accept responsibility for any damage due to incorrect installation or electrical connection.

- This appliance should not be connected through an earth leakage system. Refer to S.A.B.S. 0142.
- Support the oven in front of the aperture and make the electrical connection before installing. This will ensure enough cable length for subsequent servicing.

Connection to the power supply

The connection must be carried out by a licensed electrician, who will ensure that the oven is correctly connected and safely earthed. The rated current is printed on the serial number label attached to the oven side trim.

The appliance must be connected to the mains through a double pole isolating switch which has a minimum clearance between the contacts of 3 mm. in both poles.

A means for disconnection must be provided in the fixed wiring.

Under-counter oven installation.

- Note: **The oven cavity must vent through the front only.** Avoid gaps between the cavity sides and the underside of the worktop.
- Insert the oven into the cupboard.
- Open the door to expose the fixing holes in the side trims.
- Secure the oven by 4 countersunk screws (fasteners are not supplied).
- The hob should be installed in a ventilated cupboard fitted with a sturdy worktop.
- Secure the hob using the fixing brackets provided.

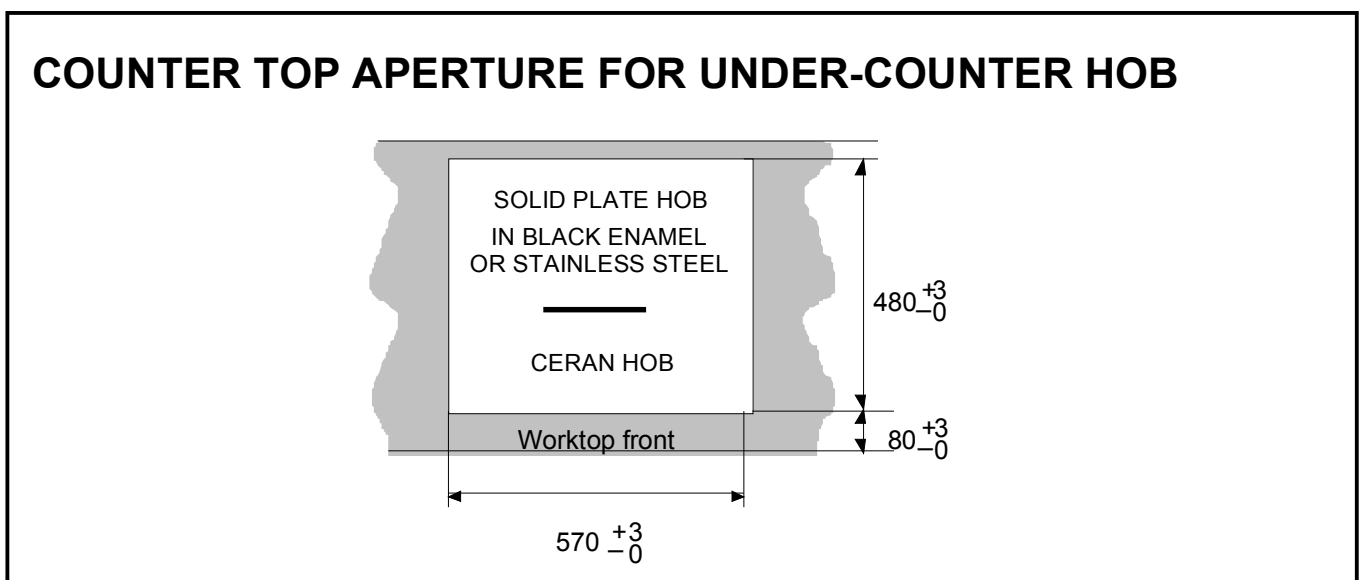
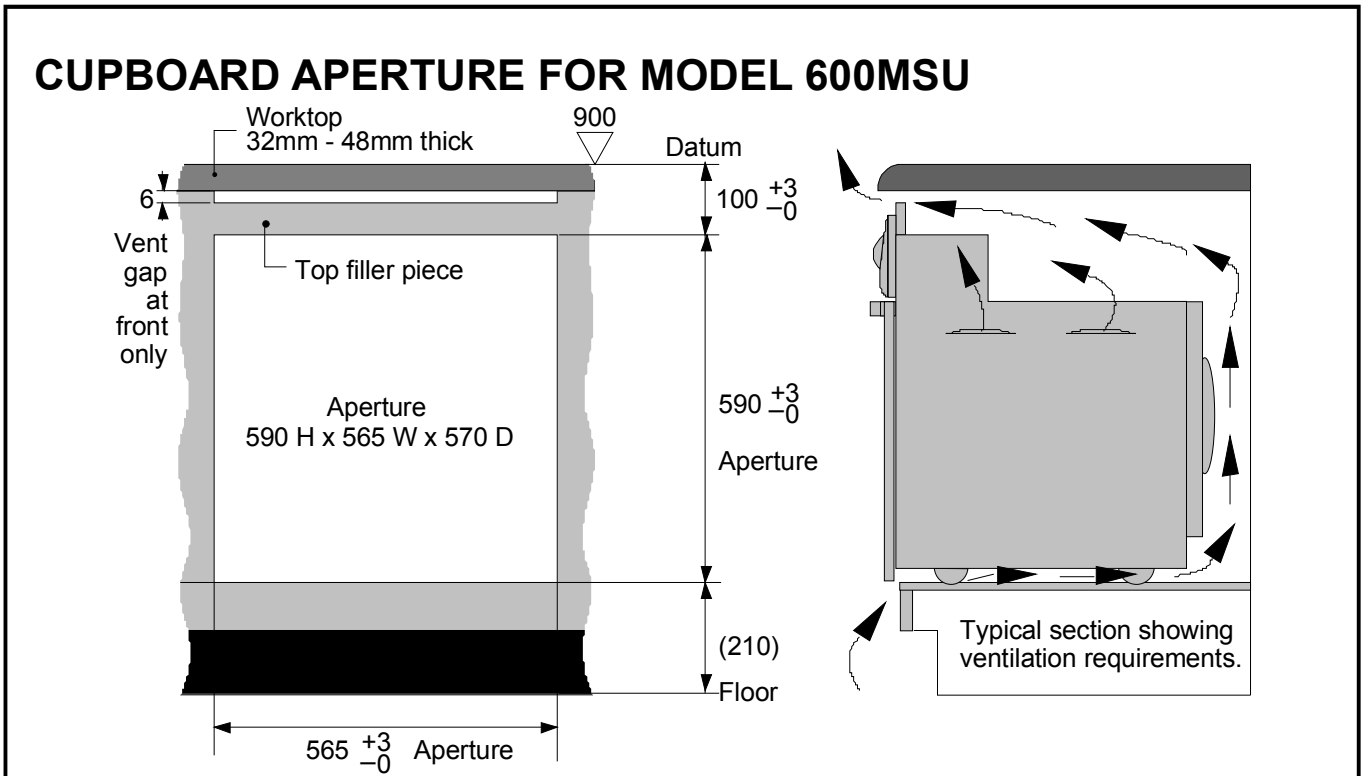

NOTE

Defy Slimline under-counter ovens may be installed at eye level if so desired.
A wiring extension kit is available from the nearest Defy Service Centre.

Eye-level oven installation.

CUPBOARD APERTURE FOR MODEL 600 MSE

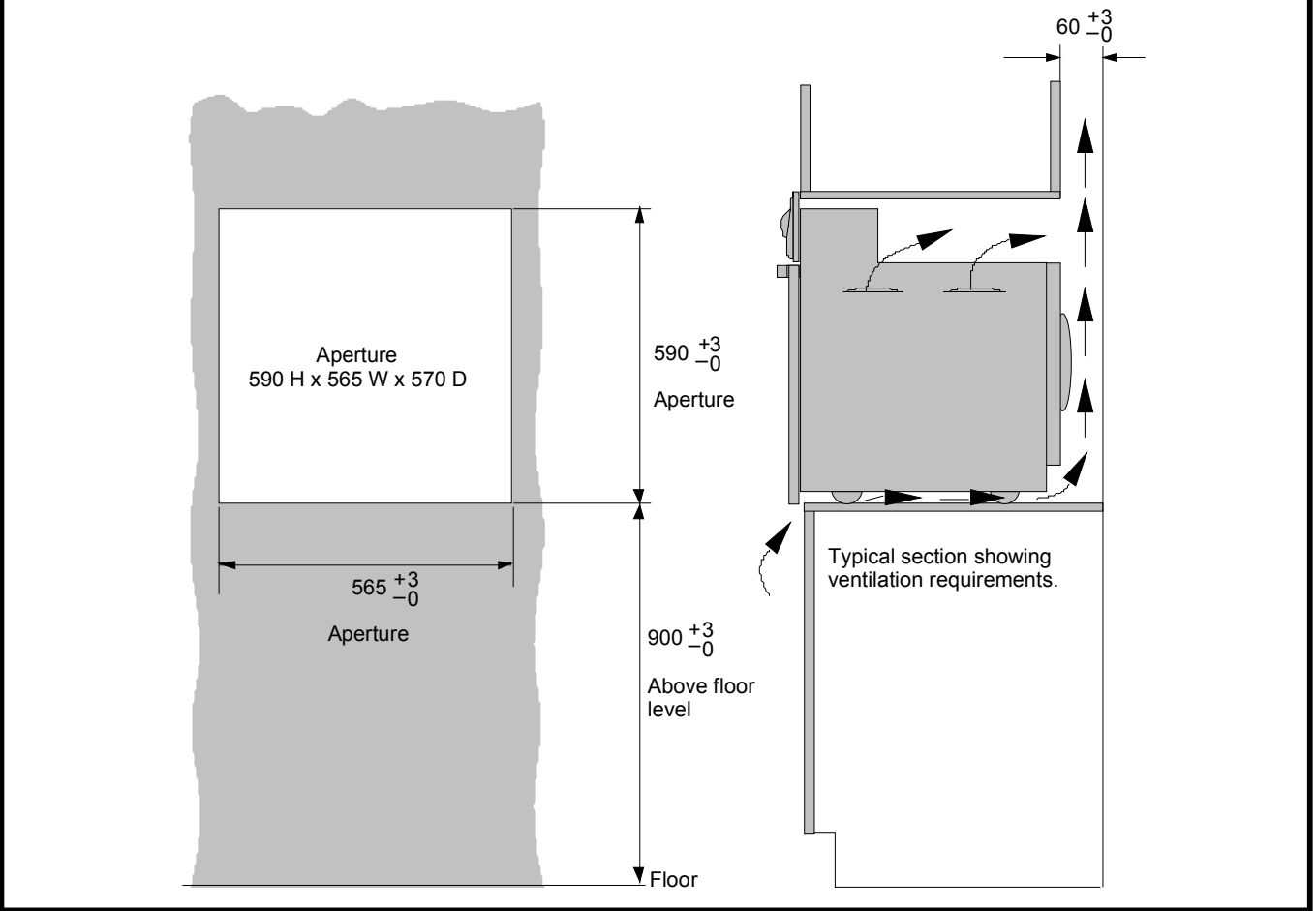

The Control Panel.

MODEL 600 MSE
EYE-LEVEL OVEN



MODEL 600 MSU
UNDER-COUNTER OVEN



MULTI FUNCTION SELECTOR

- DEFROST - FAN ONLY
- STATIC OVEN
- FAN ASSISTED OVEN
- THERMOFAN OVEN
- TURBO GRILL
- CONVENTIONAL GRILL

LEFT PLATES

CLOCK / TIMER

RIGHT PLATES

MULTI FUNCTION SELECTOR

OVEN
THERMOSTAT

The oven thermostat is marked at 70°C. When set to this position the oven may be used to keep food warm.

Automatic oven timer / clock.

- 1 = MINUTE MINDER
- 2 = COOKING PERIOD
- 3 = STOP TIME
- 4 = MANUAL CONTROL
- 5 = SUBTRACT TIME
- 6 = ADD TIME

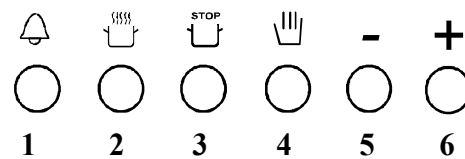

Setting the time of day

- When the power is first connected (or after a power failure), the clock display will flash **00.00**.
- To set the clock, press button 4
- Within 4 seconds, press button 5 or 6 until the correct time of day is displayed
- Release the buttons. The clock is now set.
- Please note that the clock has a 24 hour display.
- For example 3.00 PM will be displayed as 15.00.

Minute minder

- Suppose that you wish to time the boiling of a 5 minute egg.
- First boil the water.
- Press button 1. The display will show **00.00**.
- Press button 6 until the display shows **00.05**.
- Release the buttons and place the egg in the boiling water. The countdown begins and the display will again show the time of day.
- After 5 minutes the timer will emit an electronic tone. To cancel the tone, press any of the buttons (except 5 and 6).

Note:

- During the operation of the minute minder, the remaining time may be displayed by pushing button 1.
- The minute minder can be used simultaneously and independent of any automatic control programme.
- The display will always revert to the time of day after any programme has been set.

Autobake (switching the oven on and off automatically)

Autobake is intended for dishes such as roasts and casseroles. These are not affected by a waiting period in a cold oven.

- Prepare your meal and place it in the oven.
- Set the cooking period required by pressing button 2 and then 6 until the desired period is displayed.
- Set the stop time by pushing buttons 3 and then 6 until the desired stop time is displayed.
- Release the buttons and the clock will again display the time of day.
- The word **AUTO** will light up on the clock display.
- Set the **multifunction selector** to the desired function.
- Now set the **oven thermostat** to the desired temperature setting.

Autobake (Switching the oven on and off automatically) continued.

The automatic control will automatically switch the oven on and the  symbol will light up in the clock display.

Cooking will commence at the selected temperature and for the selected cooking period. The oven will automatically switch off at the selected stop time and emit an electronic tone for about one minute



The volume of tone may be adjusted while it is on, by pressing button 5.

To cancel the tone, press any of the buttons except 5 and 6.

- The word **AUTO** will flash until button **4** is pressed and **manual** control is restored.
- Return the **multifunction** selector to the **OFF** position.
- The oven **thermostat** must be turned to the **OFF** position in an anticlockwise direction.

Example:

Suppose the time of day is now 13h00. The food needs cooking for 2 hours at 180°C and it should be ready to serve at 18h00. Here's what to do.

- Ensure the clock is set to the correct time of day, **13.00**.
- Press buttons **2** and **6** until **02.00** is displayed.
- Press buttons **3** and **6** until **18.00** is displayed.
- Set the **oven thermostat** to **180°C** and the **multifunction selector** to   or .

Do not use the Autobake function for cooking periods that are less than 60 minutes.

Switching the oven off automatically

- Set the **multifunction selector** and **oven thermostat** to the required settings.
- Press and hold button **2**. The clock will display **00.00**.
- Press button **6** to select the cooking time
- Release the buttons and the clock will again display the time of day .
- The word **AUTO** and the cook symbol will light up in the display.
- After the oven will switch off automatically and emit an electronic tone for about one minute. (4 beeps every 3 seconds)
- The word **AUTO** will flash until button **4** is pressed and manual control is restored.
- Return the **multi function** selector to **OFF**
- The oven **thermostat** must be turned to the **OFF** position in an anticlockwise direction.

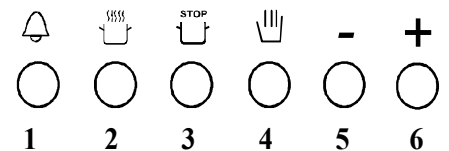









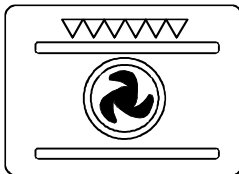

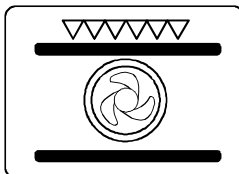
Important

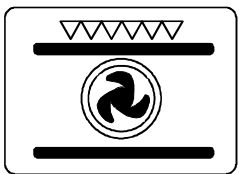
If the Automatic start and or stop functions are not required, the clock must be set to manual mode. Unless this is done, the oven will not work. Press button 4.

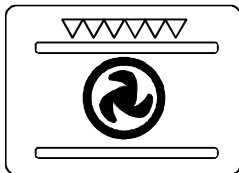
Multifunction oven

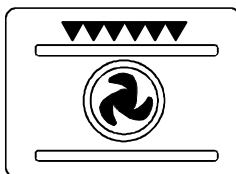
The Defy multifunction oven features 6 distinct cooking functions. (described below)
 These functions may be selected by turning the multifunction selector knob until the required function symbol is displayed at the top of the knob bezel.

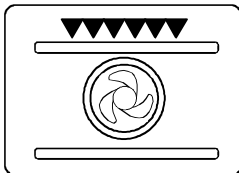
Symbol	Function	Element selection
	<p>1 Defrosting Only the fan is used. No heat is generated.</p> <ul style="list-style-type: none"> In this mode the fan at the back of the oven will circulate air at room temperature, substantially reducing the defrosting period required for frozen food. 	
	<p>2 Static Oven The bottom and top heat elements are used</p> <ul style="list-style-type: none"> Use the static oven mode for traditional baking and roasting. 	
	<p>3 Fan Assisted Oven The fan plus the bottom and top heat elements are used</p> <ul style="list-style-type: none"> Use the fan assisted oven mode for traditional baking and roasting where a more even heat distribution is required. 	
	<p>4 Thermofan Oven The fan plus the element surrounding the fan is used</p> <ul style="list-style-type: none"> Registered by Defy in 1978, Thermofan cooking differs from conventional cooking in that it uses the principle of forced convection within the oven. The advantages are: <ul style="list-style-type: none"> Both baking trays may be used at the same time. Different dishes can be cooked simultaneously without flavour or aroma transfer. Hence fish, meat and cakes can be baked at the same time. The oven door may be opened any time for inspection purposes without risk. 	
	<p>5 Turbo Grill The fan plus the grill element are used</p> <ul style="list-style-type: none"> This mode is recommended to reduce shrinkage when grilling meat or fish. 	
	<p>6 Grill Only the grill element is used</p> <ul style="list-style-type: none"> This mode is recommended for conventional grilling such as toasted cheese sandwiches. 	

Multifunction oven– Operation

WARNING: Under no circumstances should the bottom bake element be covered with aluminium foil. Nor should a pan or tray be positioned directly above the bake element.

Doing so would reflect the heat from the bake element downwards. Heat to the oven would be restricted and overheating of the space below the element would result in damage to the oven enamel.

1 Fan only Used for defrosting

- Set the **multifunction** knob to **fan only**. In this mode the fan at the back of the oven will circulate air at room temperature, substantially reducing the defrosting period required for frozen food.

2 Static Oven Used for traditional baking

- Use the **wire shelf only**. Remove the baking trays during baking in static mode as they are to be used for Thermofan baking only.
- Set the **multifunction selector** to **static oven** and the **oven thermostat** to the required temperature. The indicator light will glow and remain on until the oven has reached the selected temperature.
- When the indicator light switches off, the food should be placed in the oven.
- During cooking the indicator light will cycle on and off as the oven thermostat maintains the selected temperature.
- After completion, return the **multifunction selector** and the **oven thermostat** to the **OFF** position in an anti-clockwise direction.

Baking guide

- Bake on a wire shelf only. The recommended position is shown on the right.
- Place the food halfway between the back of the oven and the door.
- Do not open the oven door until at least two thirds of the baking time has elapsed.

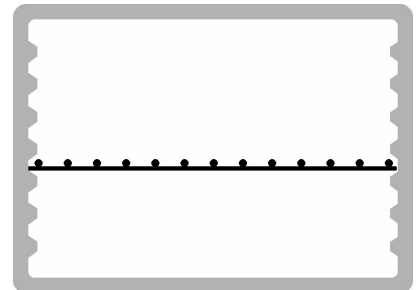

3 Fan assisted oven For traditional baking & even heat distribution

- Use **the wire shelves only**. Remove the baking trays during fan assisted mode as they are to be used for Thermofan baking only.
- Set the **multifunction selector** to **fan assisted oven** and the **oven thermostat** to the required temperature. The indicator light will glow and remain on until the oven has reached the selected temperature.
- No preheating is necessary and the food can be placed in the oven immediately.
- During cooking the indicator light will cycle on and off as the oven thermostat maintains the selected temperature.
- After completion, return the **multifunction selector** and the **oven thermostat** to the **OFF** position in an anticlockwise direction.

Baking guide

- Cooking / baking is done at slightly lower temperatures than in the static mode.
- Baking may be done on two wire shelves simultaneously.
- The recommended shelf positions are shown on the right.
- Place the food halfway between the back of the oven and the door.
- Do not open the oven door until at least two thirds of the baking time has elapsed.

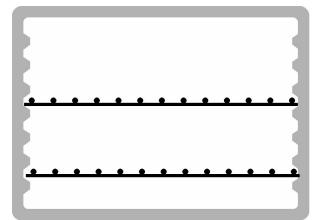

4 Thermofan oven

Registered by Defy in 1978, **Thermofan** cooking differs from conventional cooking in that it uses the principle of forced convection within the oven. The advantages are:

1. Both trays may be used at the same time.
2. Different dishes can be cooked simultaneously without flavour or aroma transfer. Hence fish, meat and cakes can be baked at the same time.
3. The oven door may be opened, after half the baking time has elapsed, for inspection purposes without risking a flop.
4. By circulating hot air around the food, spit-roast chickens may be done without using a rotisserie.
5. Cooking is done at slightly lower temperatures, saving electricity and reducing splatter.

Baking

- **Thermofan** baking should be done on one or two baking trays (supported on wire shelves) depending on volume.
- Set the **multifunction selector** to **Thermofan oven** and the **oven thermostat** to the required temperature.
- The indicator light will glow and remain on until the oven has reached the selected temperature. When the indicator light switches off, the food should be placed in the oven. During baking the indicator light will cycle on and off as the oven thermostat maintains the selected temperature.
- After completion, return the **multifunction selector** and the **oven thermostat** to the **OFF**

Recommended shelf positions

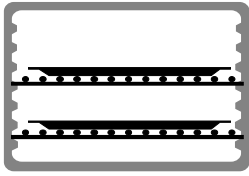

T/F BAKING

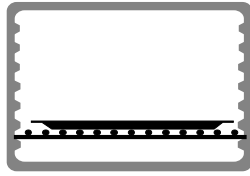

T/F BAKING

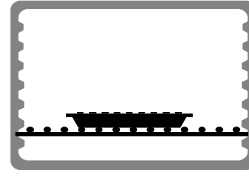

T/F ROASTING

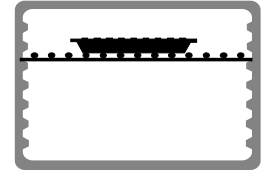

TURBO & NORMAL GRILLING

Baking guide

- **Thermofan** baking may be done on one or two baking trays depending on volume.
- **Large items:** One or two cake tins may be placed as shown and as close to the door as possible. If one tin is used, it should be placed centrally left to right.
- **Small items:** The entire area of each tray may be utilised. Avoid any time delays between positioning the two trays.
- All ovens extract a certain amount of moisture from the food being cooked. The greater capacity of the **Thermofan oven** allows more food to be cooked and thus more moisture may be released. This is normal and is not detrimental to the food or the oven.
- For professional results and perfect browning, open the oven door when half the baking time has lapsed. Then turn the baking tins around so that the sides previously facing the back of the oven now face the front.

Caution: Thermofan baking relies on good contact between the bottom of the cake tin and the oven tray. Do not use spring form baking tins with a raised bottom. The lack of contact will cause the bottom of the cake to be underdone. These tins may be used on a wire shelf where no insulating air space is created.

5 Turbo grilling. For meat and fish

- **The oven door must remain closed when Turbo grilling.**
- Use only a wire shelf when grilling as the intense heat could warp the baking trays.
- Turbo grilling is most suitable for meat as drying out and shrinkage will be reduced.
- Set the **multifunction knob** to **turbo grill**.
- Set the **oven thermostat** to the **grill position**.
- Pre-heat the grill element for about 5 minutes
- Place the food on the grid/roast pan and place this on the wire shelf near to the grill element.
- Monitor the grilling process to avoid burning the food.
- Care must be taken not to touch the grill element while handling food in the oven. If necessary, partially withdraw the shelf to improve access.
- After completion, return the **multifunction selector** and the **oven thermostat** to the **OFF** position in an anticlockwise direction.

WARNING:
ACCESSIBLE PARTS BECOME HOT DURING BAKING AND GRILLING.
ALWAYS USE OVEN GLOVES WHEN HANDLING FOOD IN THE OVEN
AND KEEP CHILDREN WELL AWAY FROM THE PRODUCT WHEN IT IS IN USE.

6 Conventional grilling.

- **The oven door must remain partially open (about 80mm.) when grilling**
- Use only a wire shelf when grilling as the intense heat could warp the baking tray.
- Set the **multifunction knob** to **conventional grill**.
- Set the **oven thermostat** to the **grill position**.
- Operating instructions are otherwise the same as those for turbo grilling mentioned previously.

NOTE

THE OVEN DOOR SHOULD REMAIN CLOSED WHEN TURBO GRILLING AND REMAIN PARTIALLY OPEN WHEN USING CONVENTIONAL GRILL.

Safety advice

This appliance is not intended for use by persons (including children) with reduced physical, sensory or mental capabilities, or lack of experience and knowledge, unless they have been given supervision or instruction concerning use of the appliance by a person responsible for their safety. Children should be supervised to ensure that they do not play with the appliance.

- Only use the oven for preparing food.
- Do not leave hot fat or oil unattended. If overheating occurs, these could catch fire.
- Switch off the mains power in the event of a fault or when cleaning the appliance.
- Do not store flammable items in the oven. If the oven is inadvertently switched on, these could catch fire.
- Never cover the bottom oven element with aluminium foil. Cooking times will be affected and the oven enamel could be damaged.
- Avoid spilling fruit juice, particularly citrus, on the oven as it could damage the enamel.
- Always keep the oven door gasket clean as this will enable the door to seal properly.

NOTE

THE CONTROL PANEL COOLING FAN PROTECTS THE CONTROLS FROM EXCESSIVE HEAT WHILE THE OVEN IS WORKING AND WILL CONTINUE TO OPERATE FOR ABOUT 20 MINUTES AFTER THE OVEN IS SWITCHED OFF

Solid plate - care guide

DO

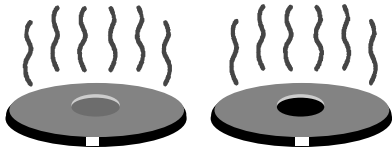

**BEFORE USING THE PLATES FOR THE FIRST TIME
SWITCH THEM ON FOR FOUR MINUTES
AT THE HIGHEST SETTING
THIS ALLOWS THE PROTECTIVE COATING
TO BURN IN**

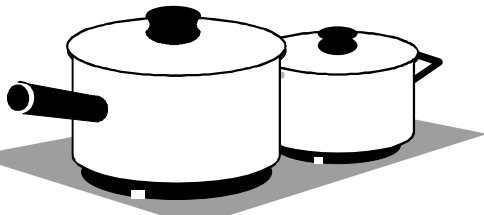

**USE POTS THAT ARE SLIGHTLY
BIGGER THAN THE PLATE
AND THAT HAVE A SMOOTH FLAT BASE**



**TO CLEAN THE PLATE - WIPE IT WITH A DAMP
CLOTH OR NYLON SCOURING PAD**

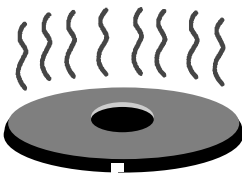

**SWITCH THE PLATE ON FOR A
SHORT PERIOD TO DRY**



**TO INHIBIT CORROSION, PERIODICALLY APPLY
SALT-FREE VEGETABLE OIL,
SEWING MACHINE OIL OR
ELECTRICAL HOT-PLATE POLISH,
(AVAILABLE FROM DEFY SERVICE CENTRES)**

DON'T

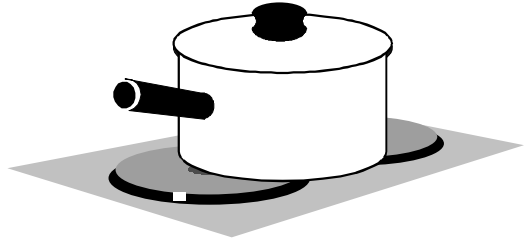

DO NOT USE ONE POT ON TWO PLATES

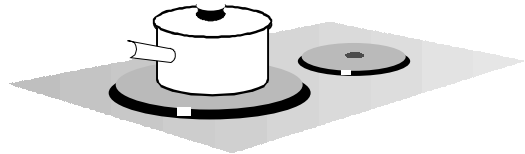

DO NOT USE A POT ON AN UNMATCHED PLATE

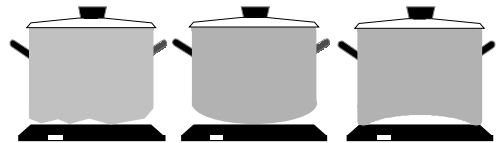

DO NOT USE A POT WITH AN UNEVEN BASE

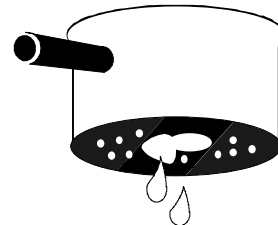

DO NOT USE A POT WITH A DIRTY OR WET BASE



**TO CONSERVE ENERGY AND AVOID SPILLS
WE RECOMMEND
YOU KEEP A LID ON THE POT.**

Solid plates For use with under-counter model 600 MSU

Plate controls

- Select the heat level by turning the relevant plate control knob to the required setting.
- The higher the number selected, the hotter the temperature of the plate will be.
- The plate indicator light will glow when a plate is switched on.

Red dot plates

- Plates featuring a red dot in the centre are high speed, high wattage plates for increased performance.
- For your safety these plates are fitted with thermal limiters. Should a plate be accidentally switched on and left unattended, the limiter will reduce the power output of the plate and minimise the risk of overheating and the possibility of fire.

Caring for Solid Plates

- Before using the plates for the first time, switch them on for about 4 minutes at the highest setting. This allows the factory applied protective coating to burn in.
- To prevent blotchy discolouration and corrosion, moisture from spatters and spills should be cleaned off immediately.
- To clean the plates, wipe them with a damp cloth or nylon pad.
- A little liquid detergent may be used.
- Do not use metal scourers or sharp metal objects to clean the plates.
- **After cleaning, dry the plates by switching them on for a short while.**
- To prevent rust, periodically apply some sewing machine oil or electrical hotplate polish available from Defy Service Centres.
- Extra attention is required in areas of high humidity or in close proximity to the sea.

Recommendations

- Use only pots with a solid level base. An uneven base can prolong cooking times and waste energy.
- Use pots with a base diameter slightly larger than the plate. This will ensure even heat distribution and prevent spillage from dripping onto and staining the hot plate.
- Always cover the pot with a lid. This will conserve energy and minimise spillage.
- Thermal shock could damage the plates. Do not put cold pots on very hot plates.

NOTE: THE WARRANTY DOES NOT COVER THE REPLACEMENT OR REPAIR OF RUSTED OR CORRODED PLATES.

Ceran smooth top. For use with under-counter model 600 MSU

Caring for the Ceran hob

- Ceran is a tough, durable material, which provides a beautiful, functional and long lasting cooking surface. To keep it looking good, it needs to be treated with care and cleaned regularly.
- Spillage should be wiped off as soon as possible with a damp cloth, preferably while the hob is still warm.
- Clean the hob with a nylon pad and 'Smooth top cleaner'. A sample tube of cleaner is supplied with the unit and replacements are available from all Defy Service Centres.
- If necessary, stubborn spills may be removed using the blade scraper provided.
- Do not use metal scourers or coarse abrasive powders as these could scratch the Ceran.
- Regular cleaning after use will prevent dirt build up and ensure that the hob remains bright and attractive.
- Wipe the hob surround with a damp hot soapy cloth and dry.

Recommendations

- Use only pots with a solid level base. An uneven base will prolong cooking time and waste energy.
- Use pots with a base diameter slightly larger than that of the thermal area. This will ensure even heat distribution and prevent spillage from dripping onto and staining the hot zone.
- Always cover the pot with a lid. This will conserve energy and minimize spillage.
- Save energy by switching the plate off 5 to 10 minutes before the end of a lengthy cooking period. The Ceran hob will retain sufficient residual heat to complete the cooking process.
- A pot with rough edges could scratch the Ceran if it were dragged across the surface of the hob.
- Any spillage of sugar solution such as jam, must be removed immediately. If allowed to cool on the Ceran it could pit and damage the surface.
- Do not cover the Ceran with aluminium foil and do not use poor quality aluminium pots. These will leave unsightly deposits which in time, could adhere to the Ceran.

Plate controls

- Select the heat level by turning the relevant plate control knob to the required setting.
 - The higher the number selected, the hotter the temperature of the plate will be.
- The plate indicator light will glow. Shortly thereafter the hot surface indicator light on the hob will switch on and will remain on for 20 to 30 minutes after the last plate is switched off. This is a reminder that the hob surface is still too hot to touch.

WARNING

In the unlikely event of the Ceran panel sustaining accidental damage and cracking, switch off the power at the mains to avoid electric shock and have the panel replaced before further use.

Maintenance.

Lift-off oven door.

The oven door may be removed to improve oven access during cleaning.

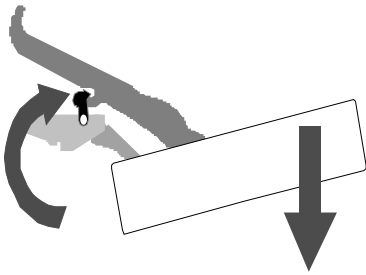

Open the door fully and flip the retainer clasps up and over the hooks on the upper hinge arms

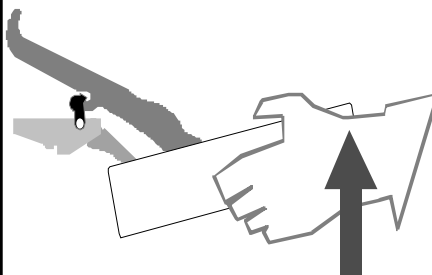

Grasp the door on both sides near the hinges. Maintain upward pressure on the door to prevent the clasps from disengaging

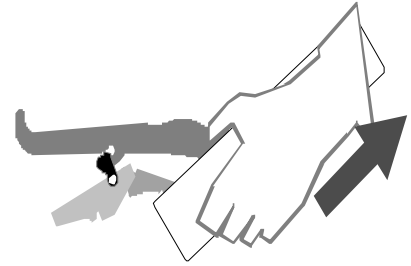

Lift the door upwards and outwards until it is free of the hinge housing.

After cleaning, refit the door in reverse order.

Oven light

The oven light is switched on by the **multifunction selector** switch and switches off when the knob is returned to **0**.

To replace a faulty light bulb, proceed as follows.

- Switch off the power at the wall switch to avoid the possibility of electric shock.
- Remove the light cover by unscrewing it in an anti-clockwise direction.
- Unscrew the faulty bulb and fit a new 25 watt bulb rated for 300°C.
- Refit the light cover.

Cleaning.

Switch off the electrical power supply before cleaning any part of the oven.

General cleaning.

- Wipe down cabinet, door, control knobs, trims and handles with a hot soapy cloth.
- Use only liquid household cleaners and avoid abrasive powders, scouring pads and caustic cleaners.
- Rinse and wipe down with a clean cloth.
- **Do not use a steam cleaner.**

Cleaning the hob plates

- For solid plates :See Page 13 of this owner's manual
- For Ceran smooth top: See page 14 of this owners manual
-

Cleaning the oven.

- Open the oven door and allow the oven to cool down.
- Clean the oven with a damp, hot soapy cloth. Do not use a steam cleaner.
- It may be necessary to soak burnt soils with a liquid cleaner to soften them before scrubbing them with a nylon brush or scouring sponge.
- Heavy soils on the bottom of the oven may require overnight soaking under a sponge liberally sprinkled with household ammonia. The soil can then be removed the following morning by washing normally.
- Do not use metal objects or steel wool to clean the oven.
- For your convenience, the shelves and the bake element guard may be removed to improve access.
- After cleaning fit the bake element guard into the guard clips. (see diagram)
- **Note: For both safety and performance reasons the oven should not be operated without the oven element guard in place.**

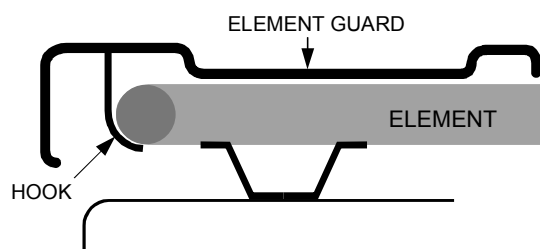

Care guide for stainless steel.

For models 600MSE and 600 MSU model 600 MSU

Stainless steel is not adversely affected by normal household use but because of its reputation for durability, it is sometimes assumed to be indestructible, and therefore subjected to misuse or even abuse. Care should be taken to avoid such 'abnormal use'.

Cleaning materials

DO USE

- A soft cloth or synthetic sponge.
- Soap, or a mild household detergent.
- Diluted ammonia in warm water.
- A nylon bristle brush.
- Cleaners labelled "Suitable for stainless steel".

DO NOT USE

- Acids.
- Coarse abrasive cleaning powders.
- Metallic scourers, steel wool or metal scrapers.
- Wire brushes or emery paper.
- So called 'silver cleaners'.
- Kitchen scourers/foam pads.

Cleaning procedure

- Frequent cleaning is recommended rather than an occasional aggressive clean.
- Routine cleaning will preserve the corrosion resistance and appearance of the stainless steel for many years.
- Clean the stainless steel as often as necessary (i.e. when noticeably dull or dirty) and use the simplest cleaning method that will effectively do the job.
- Use clean water, or a mild detergent solution applied with a soft cloth or sponge. Rinse well and wipe dry.

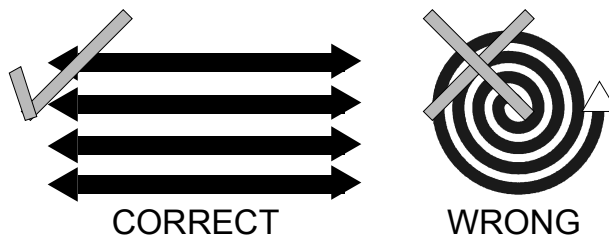

**ALWAYS WIPE IN THE DIRECTION OF
THE BRUSHED TEXTURE ON THE STAINLESS STEEL**

CONDITION	ACTION	NOTES AND COMMENTS
Requires routine cleaning.	Mild detergent solution applied with soft sponge or cloth. Rinse and wipe dry.	If possible use warm to hand-hot water. A 5% addition of ammonia is beneficial.
Finger prints.	Pre-treat finger marks with alcohol or an organic solvent. Follow immediately with routine cleaning.	Minimize re-occurrence by applying a wax or silicone based household polish to the clean dry surface.
	Wipe with a little baby oil and a soft lint free cloth. Buff to shine.	Apply whenever necessary.
Stubborn stains and Discolouration.	Use a little Ceran cleaning paste. (available from Defy Service Centres). Rinse and dry.	Repeat several times rather than resorting to a single aggressive cleaning method.
Grease and fat splatter.	Wipe off excess with a soft cloth or paper towel. Use a water borne degreasing agent (dishwashing liquid).Follow up by routine cleaning.	
Scratches on the brushed finish.	For slight scratches, use a nylon pad loaded with an iron-free abrasive polishing compound. Follow the direction of the original texture. Follow up with routine cleaning. For deep scratches use a coarser abrasive initially and follow up as for light scratches.	Deep scratches will be difficult to remove completely. Do not use steel wool or metal scourers unless they are made from stainless steel.

IT MUST BE APPRECIATED THAT SOME OF THE SUGGESTED PROCEDURES WILL ALTER THE SURFACE APPEARANCE OF THE TREATED AREA. THEY SHOULD THEREFORE BE APPLIED WITH DUE CONSIDERATION AND CARE.



OVER THE YEARS, DEFY'S SERVICE CENTRES HAVE IDENTIFIED THIS LIST OF DO'S AND DON'TS AS BEING IMPORTANT FOR CUSTOMER SATISFACTION AND SAFETY. PLEASE READ IT AND FAMILIARISE YOURSELF WITH ITS CONTENTS.



Do

- **Clean your appliance regularly. This will prolong its good looks and enhance hygiene levels.**
- **Use flat bottomed pots and pans when cooking on the hotplates. This will maximise efficiency and reduce electricity costs.**
- **Keep children well away from the cooking appliance. Explain the dangers to them. Being safety conscious is being safe, not sorry.**
- **Supervise the cooking process. Overcooked or spoiled food is wasteful.**
- **Leave about a 40mm. air gap between baking tins and the oven walls. Adequate air circulation is important for good baking results.**
- **Get into the habit of wearing oven gloves when handling utensils in a hot oven. This will help to avoid accidental burns.**
- **Partly slide out the oven shelf before removing hot dishes from the oven. This will prevent accidental contact with the hot oven sides.**

Don't

- **Use pots which are smaller than the hotplate diameter. This wastes electricity and allows the pot handles to overheat.**
- **Leave the appliance unattended especially when grilling. This is good practice and avoids accidents.**
- **Place anything on the open oven door. The glass is not a work surface and could get scratched.**
- **Use abrasive cleaning materials. They will scratch surfaces and facial graphics.**
- **Allow fat splashes to dry and bake onto the stove/oven surface before cleaning them. It is easier to clean spills while they are still slightly warm and soft.**
- **Put baking tins on the floor of the oven. This will prevent heat circulation and spoil baking results.**
- **Use the appliance to heat the home. Neither the hotplates nor the oven were designed for this purpose and damage could occur.**
- **Allow pot handles to overhang the front of the appliance. Children might be tempted to grab them with harmful consequences.**

Owner's responsibility.

WARNING: Under no circumstances should the bake element be covered with aluminium foil. Nor should a pan or tray be positioned directly above the bake element. Doing so would reflect the heat from the bake element downwards. Heat to the oven would be restricted and overheating of the space below the element would result in damage to the oven enamel.

Since the following are not factory faults, they are the owner's responsibility.

- Damage to exterior finish.
- Breakage of glass and other components.
- Replacement of the light bulb.
- Damage through improper installation or use of the appliance.
- Damage caused by moving the appliance.

Problem check.

Do not attempt any repairs yourself.

Before calling a service technician to assist with a problem, please check:

- The mains distribution board for tripped circuit breakers.
- That the wall switch is on.
- Remember that you may be charged for a service call even during the warranty period if the fault is due to or caused by any of the above.

If you have followed the instructions and still have a problem, contact the nearest Defy Technical Support Centre. They will be able to advise you on any aspect of the product or send a qualified technician to repair it.

Defy Service Centres

BLOEMFONTEIN 160 Long Street, Hilton,
Bloemfontein 9301.
Tel. 051 400 3900
Bloemfontein.Service@defy.co.za

CAPE TOWN 5A Marconi Rd.
Montague Gardens, 7441.
Tel. 021 526 3000
CapeTown.Service@defy.co.za

DURBAN 35 Intersite Avenue,
Umgeni Business Park, Durban 4051.
Tel. 031 268 3300
Durban.Service@defy.co.za

EAST LONDON 16 Bowls Rd. Arcadia,
East London 5201.
Tel. 043 743 7100
EastLondon.Service@defy.co.za

JOHANNESBURG Cnr. Mimetes & Kruger Sts. Denver ext.12
Commercial Head Office, Johannesburg. 2094.
Administration, Distribution, National Groups, Tel. 011 621 0200 or 011 621 0300
Tel. Sales, Contracts and Credit. Gauteng.Service@defy.co.za

POLOKWANE 87 Nelson Mandela Drive.
Superbia 0699.
Tel. 0152 92 1166 / 7 / 8 / 9.
Polokwane.Service@defy.co.za

PORT ELIZABETH 112 Patterson Road,
North End, Port Elizabeth 6001.
Tel. 041 401 6400
PortElizabeth.Service@defy.co.za

PRETORIA. Block A1 Old Mutual Industrial Park.
Cnr. D.F.Malan Drive & Moot Str.
Hermanstad. 0082.
Tel. 012 377 8300
Pretoria.Service@defy.co.za

**OTHER AREAS ARE SERVICED BY OVER 200 AUTHORISED AGENTS.
FOR FURTHER DETAILS PLEASE CONSULT THE NEAREST REGIONAL
DEFY TECHNICAL SUPPORT CENTRE**

Warranty

This certificate is issued by DEFY APPLIANCES (PTY) LIMITED manufacturers of Defy and Ocean products, hereinafter the Company, to the original purchaser only, of the appliance described on the certificate and shall constitute the only warranty given in respect of this appliance.

The Company warrants to the original purchaser that for a period of TWO YEARS from date of purchase the appliance is free from defect under normal domestic use, both in workmanship and material, subject to the following conditions.

1. Repair or replacement of any part of this appliance, found by the Company to be defective, shall be at the election of the Company. The Company reserves the right to effect such service through any of its Service Divisions or Authorised Service Dealers. The cost of such service shall be borne by the Company in full, provided that the appliance is located no further than 50 km from a Company Service Centre or an Authorised Service Dealer. Where the appliance is located beyond the 50 km radius, the purchaser shall be liable for the standard travelling charges, as determined by the Company. CARRY IN SERVICE Microwave ovens, Compact cookers and small appliances are repaired in our service centres and are not collected from the customers home. Faulty units should be delivered to the purchasing dealer or to the nearest Company Service Centre for warranty repairs.
2. Rusted or corroded plates, vitreous enamelware, fuses and lamps are specifically excluded from these warranties. It is an express condition of these warranties that the purchaser takes due care and attention in the use and maintenance of the appliance. Abuse, misuse in conflict with operating instructions, connection to incorrect voltages and subjection to commercial use shall release the Company from its obligations.
3. This warranty shall become void and cease to operate if the appliance is dismantled by, or any repairs to the appliance are effected by any persons not duly authorised by the Company, or if substitute parts not approved by the Company are used in the appliance, or if the serial number of the appliance is removed.
4. The Company shall not be responsible for damages resulting from fire, flood, civil disturbances or any Act of God. The Company shall not, in terms of these warranties be responsible nor held liable for any consequential loss or damage of any kind caused by or due to the failure or malfunction of the appliance.
5. The Company shall not be responsible for transportation or other costs other than those incurred within the provisions of Point 1 of this Certificate.
6. These warranties shall not apply to the appliance if it is purchased or used beyond the borders of the Republic of South Africa, Namibia, Botswana, Swaziland and Lesotho.
7. Where service is requested under warranty and no fault or defect can be found by the Company, all costs incurred will be for the purchaser's account.
8. This Certificate as well as your invoice will serve as proof of purchase. For the purpose of warranty, it will be essential to produce this Certificate and invoice. Failure to do so, will render the purchaser liable for service costs.

**KEEP THIS CERTIFICATE AND SALES INVOICE AS PROOF OF
PURCHASE FOR WARRANTY PURPOSES.**

Notes:

For future reference, record the listed information in the space below.
The Serial number may be found on the label attached to the oven side trim.

SERIAL No

.....

DATE OF PURCHASE

.....

PURCHASED FROM

.....

.....

.....

DEFY SLIMLINE 600MSU



DEFY SLIMLINE 600MSE



**Defy Slimline
600 MSE AND 600 MSU
Multifunction Ovens**

Multifunction.	A choice of six cooking modes.
Defrost.	Speeds up defrosting.
Conventional cooking.	Traditional top and bottom elements.
Fan assisted cooking.	Allows traditional baking on two shelves.
Thermofan cooking.	Excellent for bulk baking. No flavour transfer and saves electricity.
Conventional cooking and grilling.	Traditional baking and grilling at its best.
Turbo grill.	Superior grilling. Reduces splatter.
Stainless steel cosmetics.	Modern and hard wearing.
Removable door.	Allows improved access for cleaning purposes.
Automatic oven timer.	Start time, cooking time, minute minder and time of day.
Roast pan and wire rack.	Accessories for cooking convenience.



You can rely on Defy. To simplify

The Manufacturer strives for continuous improvements. For this reason, the text and illustrations in this book are subject to change without notice.

Part Number 067 230